

Gas Log Flame Fire Collection



Rinnai
Relax. It's a Rinnai.

Driven to create comfort.

We are motivated to engineer relaxation and well-being in your home and life. Our full range of gas log fire products illustrate this determination; we are passionate about creating beautifully designed products that truly capture the essence of luxury comfort in the home.

With commitment to ongoing innovation, we endeavour to offer heating products that feature safety, control, convenience and versatility to ultimately deliver reliability. Relax, it's a Rinnai.

Our Focus

Design

A Rinnai gas log fire provides more than just heat. As a centre piece to your home, a truly warm focal point, we understand the importance of design – and it's at the heart of what we do. Our approach to design and function ensures we deliver forward thinking, innovative products that you're proud to have in your home.

Energy efficiency

Constantly front of mind at Rinnai, we strive to ensure our products are friendly to the environment and your hip-pocket. With energy star efficiency ratings as high as 5.5 stars*, we are pushing new boundaries of energy efficiency.

Quality

Meticulous engineering, precision manufacturing and strict quality assurance procedures are the hallmarks of our ongoing focus on quality products. Our obsession with excellence means you can relax knowing you've made the right choice.

Warranty

We're confident in the quality of our products, so much so that we offer 10 years domestic warranty on the heat exchanger, 2 years on the fan and 1 year for all other parts/labour for all Rinnai gas log fire appliances.

Safety

All Rinnai gas log fire appliances are equipped with a range of safety features, giving you peace of mind.

Simple installation

The Rinnai range of gas log fires are engineered with ease of installation in mind. We strive to ensure that all components of our fires are designed for simplicity and easy access, allowing a quick and hassle-free installation.

Support

We operate a Melbourne based national customer administration centre, offering advice and information on all our products to homeowners, retailers, plumbers, builders, architects and the like. Contact us on Monday to Friday, 8:00am to 5:30pm on 1300 555 545.

*Star rating depends on installation and flueing configuration



1250 | Gas Log Fire





A Gas Log Fire that's sure to have wide appeal.

Introducing the new Rinnai **1250** – the latest innovation in Gas Log Fires. At over 1.3 meters wide, the long landscape design will make a bold statement in your home. Stunning design, energy efficiency, installation flexibility and high heat output are the hallmarks of the 1250 – so you can relax, for longer.

- > Highly efficient 5.5 star energy rating*
- > Powerful heat output up to 8.4kW, perfect for open plan living areas†
- > Available with either glowing pebbles or Australian Eucalyptus logs
- > Installation designed specifically for new homes and major renovations
- > Safety mesh guard to provide peace of mind and eliminate reflections
- > Thermostatically controlled
- > Flexible power flueing
- > Remote control included as standard.
- > 3 speed fan with quiet operation.

*When installed using extended flue. †When using short flue.

1250 | Gas Log Fire

Design Options



Black on Black Frame



Stainless Steel on Black Frame



Australian Eucalyptus log set



Glowing Pebbles with Optional Side Reflector Panel

Flueing Options

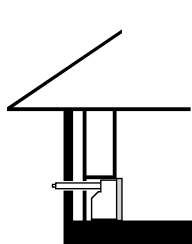

Rear External Wall

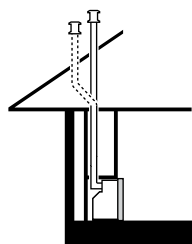

Vertical

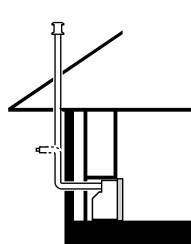

Through Wall

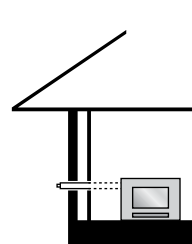

Sideways Through Wall

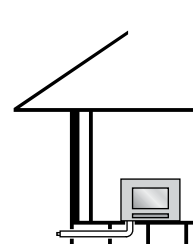

Down and Out

950 | Gas Log Fire





Spread the warmth and comfort.

The 950 represents a new generation of gas fires for Rinnai. Designed to meet the highest expectations in terms of simple installation, powerful heat output, energy efficiency and flueing flexibility, the 950 is the future of fire.

This gas log fire offers a mix of modern frames and burn media options, giving you the ultimate flexibility to create a space that is your own. The classic 'cut wood' look of the Australian Eucalyptus Log Set provides a beautiful dancing flame, whilst the glowing Pebbles radiate warmth with a modern twist.

- > High 5.5 star energy efficiency rating*
- > Heat output up to 8.1kW, perfect for open plan living areas†
- > Thermostatically controlled
- > Flexible power flueing
- > Remote control included as standard.

*When installed using extended flue. †When using short flue.

950 | Gas Log Fire

Design Options



Stainless Steel on Black with Pebbles



Black on Black with Australian Eucalyptus Logs



Flueing Options

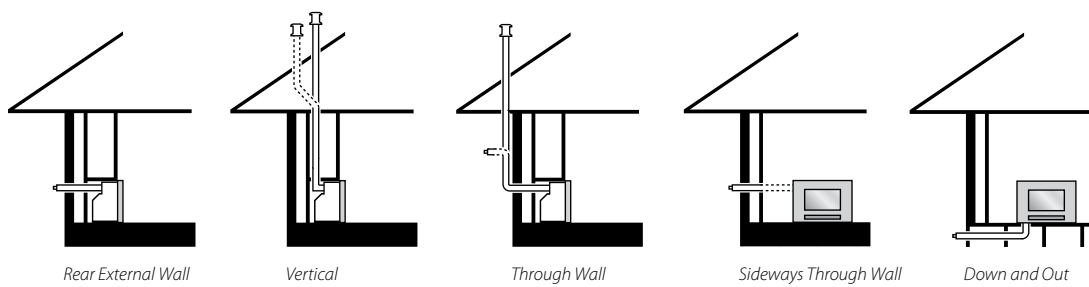

Rear External Wall

Vertical

Through Wall

Sideways Through Wall

Down and Out

Symmetry | Gas Log Fire



* Photography and design by Kavellaris Urban Design. Please note the decorative flue shown on the Symmetry is not supplied by Rinnai.



Find your
perfect symmetry
this winter.

The Symmetry gas log flame fire is the perfect solution to creating an ambient atmosphere in a new home or major renovation.

With a flush, thin frame and wide panoramic orientation, the Symmetry creates a beautiful look that will catch the eye of any design conscious individual.

This gas log fire combines Australian eucalyptus logs with stones on a bed of ashes that provide a warm, glowing base to the flickering flames. Complete control of the room temperature makes the Symmetry an absolute luxury. Every fire comes with a remote control that offers full electronic thermostatic control.

- > 4.2 Star energy efficiency rating
- > Heat output up to 7.6kW
- > Programmable timers
- > Remote control included as standard.
- > Optional side reflector mirrors available, designed to enhance the flame picture.

Symmetry | Gas Log Fire

Design Options



Bevelled Black



Bevelled Silver



Square Black



Square Stainless Steel on Black

Flueing Options

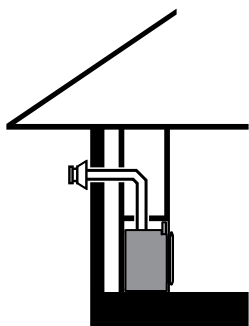

Direct Flue Kit installation

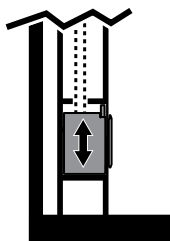

Elevated installation

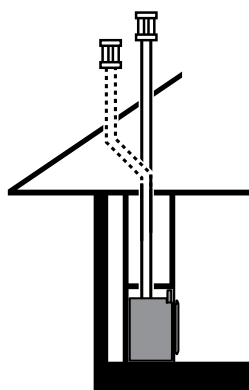

Vertical

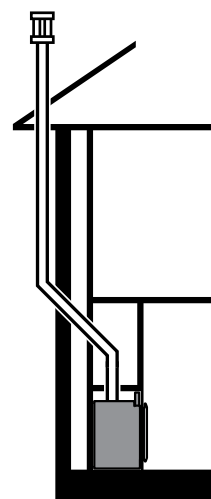

Through Wall

Sapphire | Gas Log Fire





Relax in warmth
and comfort
with this gem.

The Sapphire gas log flame fire gives you all the appeal of an open wood fire, without any of the bother that goes with it.

Perfect for the replacement of an old, inefficient wood or space heater, the Sapphire is specifically designed to fit into an existing fireplace without any additional flueing required. This gas fire is also available in a variety of freestanding options, or may also be installed in a mock fireplace.

- > 4.1 Star energy efficiency rating
- > Powerful 6.97kW output - suitable for heating large open areas
- > Programmable 4 period timer
- > Stylish glass dress guard for protection
- > Optional remote control available

Sapphire | Gas Log Fire

Design Options



Stainless Steel



Black



Stainless Steel on Black



*Classic Silver**

*Available in inbuilt only.



*Classic Bronze**

Flueing Options

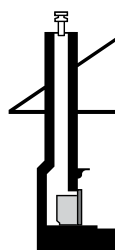

Inbuilt Masonry

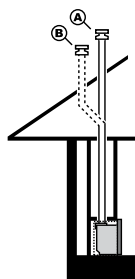
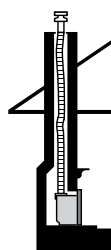

Inbuilt Zero Clearance

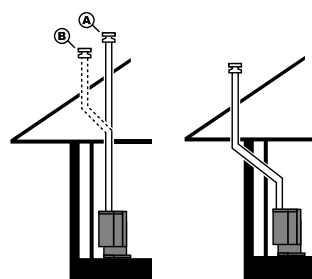
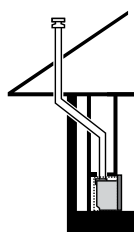

Freestanding (Floor & Plinth)

752 | Gas Log Fire



Warmth and
comfort
have never
looked so good.

Available in four stylish designs and featuring double-glazed fascia for a sleek aesthetic, **the 752** Gas Log Flame Fire will be a highly attractive focal point in any new home or modern renovation.

The ambience and glow of flickering flames also provides comforting warmth to large open plan living areas. With a variety of options to suit your home, the 752 will be a welcome addition this winter.

- > High 4.1 Star efficiency rating
- > 6.97kW heat output
- > Dual digital timers
- > Preheat mode
- > Thermostatically controlled - remote included with every fire



752 | Gas Log Fire

Design Options



Flat Stainless Steel Metal



Flat Black Metal



Black on Black



Stainless Steel on Black

Flueing Options

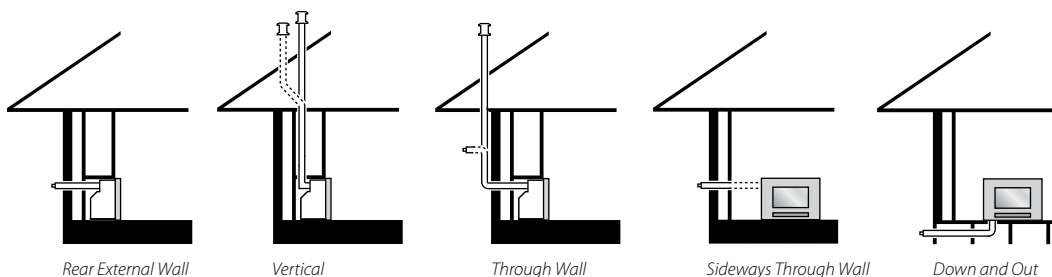

Rear External Wall

Vertical

Through Wall

Sideways Through Wall

Down and Out

Slimfire 252 | Gas Log Fire



An attractive
slim-line you'll
really warm to.

The Slimfire 252 is the perfect solution if you want plenty of heat but only have a small amount of space. This fire has been specifically designed to fit into smaller existing masonry fireplaces or smaller living rooms.

- > 2.8 Star energy efficiency rating
- > 5.0kW heat output
- > Easy one-touch manual ignition
- > Perfect replacement for old space heaters
- > 2 speed fan to quickly disperse warmth around the room
- > Standard log set supplied with every Slimfire 252



Slimfire 252 | Gas Log Fire

Design Options



Stainless Steel on Black



Black



Stainless Steel

Flueing Options

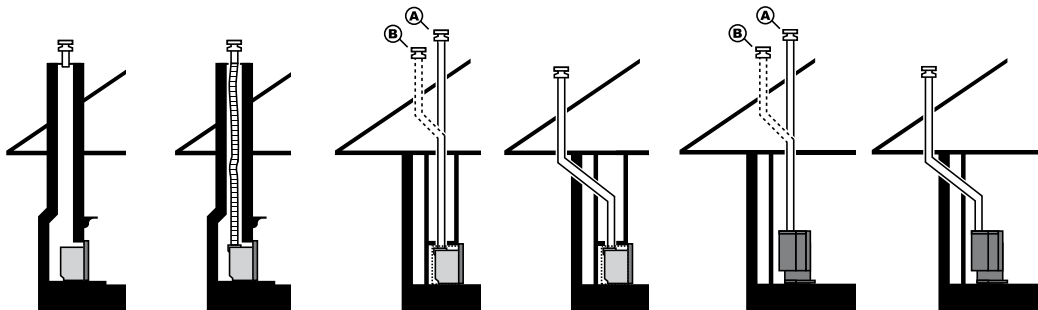

Inbuilt Masonry

Inbuilt Zero Clearance

Freestanding (Floor & Plinth)

No need to make a **snap decision.**

Picture the right flame fire for your room with Rinnai's new Fire app.

Selecting the right gas log fire for your home can be a difficult task. With a huge range of different design options, making the right choice that suits your living space can be a daunting decision.

That's why we've developed an innovative solution that lets you trial a Rinnai gas log fire with the touch of a button!

If you have an iPhone/iPad or Android phone, simply follow the below instructions and in a few easy steps, you can experiment with our range of fireplace designs and find your favourite.

1. Download the free Rinnai Fire app from Google Play or Apple iTunes Appstore by searching "Rinnai".
2. Get your hands on a copy of any Rinnai gas log fire product flyer, available at your nearest store or online.
3. Hang the product flyer on the wall in the ideal position you would like the fire to be.
4. Open the Rinnai Fire app, follow the instructions on screen to scroll through different fireplace design options.
5. Click the 'Magic Button' to launch the 'Magic View'
6. Focus your phone's camera on the product flyer. After a moment a Rinnai fireplace should appear on screen.

Save the image and share with your friends!





Installation Options

Whether you are building a new home, working through a major renovation or just want to revamp your living room, the Rinnai zero clearance option is the perfect solution to creating a new space.

If your home doesn't have an existing fireplace, creating a false fireplace is the next best thing. To ensure an easy installation into a timber frame or other combustible materials, the Rinnai 1250, 950, 752 and Symmetry are designed with an integrated zero clearance box.

The Sapphire and Slimfire can be installed with the purchase of an additional zero clearance box.

Creating a False Fireplace

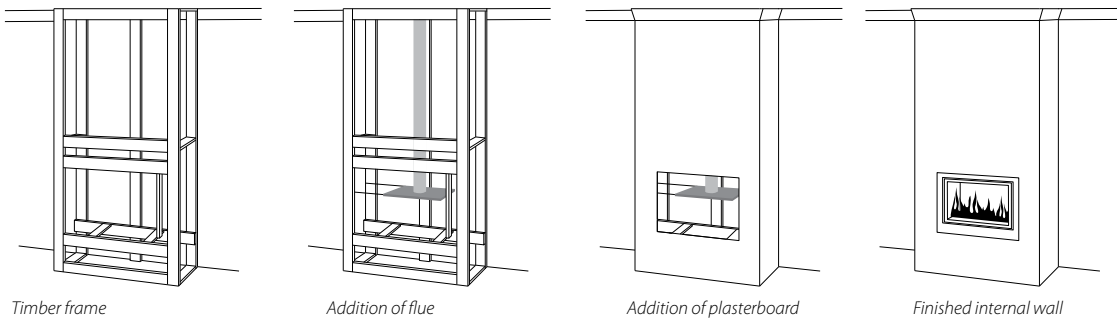

Weatherproof Box

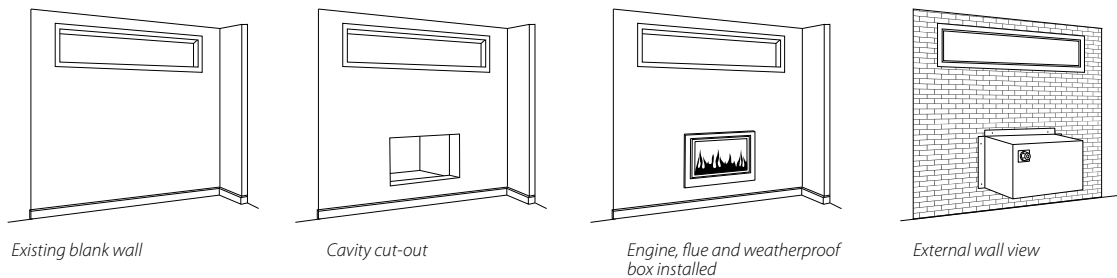

For an alternative installation to a false fireplace, the Rinnai 1250 & 950 can be installed into a weatherproof box. A cavity is cut into the existing blank wall and the fireplace is installed onto a bracket that allows the back of the fire to sit outside housed in a tightly sealed box. This option allows the fire to be built into an existing wall without taking up any extra space in the room. The weatherproof box is sold separately.

Gas Log Flame Fire Specifications		Slimfire 252	Sapphire	Symmetry	752	950	1250
Style		Inbuilt	Freestanding / Inbuilt	Inbuilt	Inbuilt	Inbuilt	Inbuilt
Visual Dimensions (mm)	H	645	660	643	710	660	660
	W	750	865	1110	1050	1070	1320
	D	70	62	14	100	25	25
Inbuilt Cavity Dimensions (mm)	H	550-630	660*	850	660	570	570
	W	595-700	695*	1100 - 1125	860	965	1265
	D	Min. 360	370*	Min. 600	450	570	570
Gas Types		NG/LPG					
Gas Input MJ/h	Low	7.7	14	19	8	10	10
	High	25	30	33	31.5	34	34
kW Output		5	6.97	7.6	6.97	8.13	8.4
Heats Up to Capacity (m²)	Very Cold	42	60	64	58	69	69
	Cold	50	70	76	69	82	82
	Cool	68	95	103	94	110	110
	Mild	77	108	117	107	125	125
AS4553 Efficiency Star Rating		2.8	4.2	4.2	4.1	5	5.2-5.5**
Thermostatic or Manual Control		Manual 3 Settings	Manual / Optional Remote Thermostat	Thermostatic	Thermostatic	Thermostatic	Thermostatic
Dual Timers		N/A		N/A	Yes	Yes	Yes
Multiple Timers			Only w/ remote	Yes	N/A	N/A	N/A
Preheat Feature					Yes	Yes	Yes
Auto Off Mode			Yes	Yes	Yes	Yes	Yes
Override Button					Yes	Yes	Yes
Flame Function			Yes	Yes	Yes	Yes	Yes
Child Lock or Lock Button					Yes	Yes	Yes

*Masonry fireplace dimensions only, see Rinnai website for further details

**Star rating depends on flueing configuration

Warranty	Heat Exchanger	Fan	All Other Parts	Free Labour
Domestic Use	10 years pro rata ⁽¹⁾	2 years	1 year	1 year
Commercial Use	1 year on all parts and labour			

Please note: For full definitions of Domestic and Commercial use, along with other conditions and exclusions, please refer to www.rinnai.com.au ⁽¹⁾ Full replacement cost in the 1st year, reducing 10% per year thereafter. 240V power is required on all models. Mandatory dress guards are not shown for illustrative purposes.

Dealer Details:

Rinnai Australia Pty Ltd

ABN 74 005 138 769

100 Atlantic Drive, Keysborough, Victoria 3173

For further information visit

www.rinnai.com.au

or call 1300 555 545